

NILSON

Design Lievore Altherr 2017





Caratteristiche: Nilson è un modello dalla linea innovativa la cui caratteristica principale è l'elevata comodità. È disponibile in due versioni: con lo schienale Alto o con lo schienale Basso. La versione Alta (alla quale raccomandiamo di aggiungere i cuscini bracciolo opzionali) è dotata di un poggiatesta reclinabile in diverse posizioni che lo rende ergonomicamente perfetto, offrendo una comodità insuperabile. Nilson, nella versione Basso (che può "vivere" anche senza cuscini bracciolo), è dedicato a chi preferisce una seduta informale dal tratto contemporaneo. Per entrambe le versioni sono disponibili tre diverse misure di divani, tre diverse misure di laterali oltre alla chaise longue, alla poltrona lunga, al daybed e un pouf. La poltrona girevole con il suo pouf completa la collezione. La struttura del bracciolo è disponibile su richiesta in rigenerato di fibra di cuoio, tagliato e cucito al vivo, color testa di moro, senza supplemento di prezzo. Il rivestimento è completamente sfoderabile ad eccezione della versione in pelle. **Struttura:** Fusto in legno multistrato e massello imbottito in poliuretano espanso indeformabile, priverestimento con Velfodera, piedi in fusione di alluminio verniciati color bronzo. **Imbottiture:** Cuscini di seduta in poliuretano indeformabile a densità differenziata e fibra poliestere, cuscini schienale in piuma canalizzata con inserto in poliuretano indeformabile. I cuscini bracciolo (opzionali) sono interamente in piuma. Tutte le imbottiture sono interamente rivestite in tela bianca.

Features: Nilson is a model with an innovative design characterized by a high level of comfort. It is available in two versions: with High or Low backrest. The High version - for which the optional armrest cushions are recommended - is provided with a reclinable headrest, which makes it ergonomically perfect and offers an amazing comfort. Nilson in the Low version - that can "live" without armrest cushions - is thought for those who prefer an informal seat and a contemporary style. Three sizes of sofas, three sizes of side pieces, a chaise longue, a long armchair, a daybed and a pouf are available for both versions. A swivel armchair and a pouf complete the range. The structure of the armrest is available upon request in regenerated leather fiber, with visible cut and sew, dark brown, no extra charge. The cover can be completely and easily removed except for the leather version. **Framework:** Frame made of solid and plywood, padded with non-deformable expanded polyurethane of differentiated density. Lining in Velfodera. Feet are in bronzed painted aluminium cast as standard. **Cushion Padding:** Seat cushions in non-deformable expanded polyurethane with differentiated density and polyester fibre, backrest-cushions in canalised feathers with non-deformable polyurethane insert. Optional armrest cushions are entirely in feather. All padding is fully lined with white fabric.

Eigenschaften: Nilson ist ein Modell innovativer Linie, dessen Hauptmerkmal der hohe Grad an Komfort ist. Es ist erhältlich in zwei Versionen: mit hoher oder niedriger Rückenlehne. Die „Hohe Version“ (empfehlenswert sind hier die optionalen Armlehnkissen) mit der neigbaren Kopfstütze bietet eine perfekte Ergonomie und extremen Komfort. Die niedrige Version (sie kann auch ohne Armlehnkissen „leben“) richtet sich an diejenigen, die das Informelle und moderne Linien lieben. Für beide Versionen sind drei verschiedene Größen der Sofas, drei verschiedene Größen der Seitenteile, die Chaiselongue, der Longchair und das Daybed verfügbar. Der Drehsessel mit seinem Hocker vervollständigt die Kollektion. Die Struktur der Armlehne ist auf Anfrage in dunkelbraunem Bonded Leder mit Steppnaht erhältlich, ohne Aufpreis. Die Bezüge sind komplett abnehmbar, mit Ausnahme der Lederausführung. **Struktur:** Korpus aus Massiv- und Mehrschichtholz, gepolstert mit formstabilem Polyurethan und Unterbezug Velfodera. Füße in bronzefarben lackiertem Aluminiumguss. **Polster:** Sitzkissen aus formstabilem Polyurethan differenzierter Dichte und Polyesterfaser; Rückenkissen aus in Kammern gesteppten Federn und einem formstabilen Polyurethankingern. Die optionalen Armlehnkissen haben eine komplette Federfüllung. Alle Polster sind mit einem weißen Unterbezug verkleidet.

SEZIONE SECTION SEKTION

- 1:** Poliuretano a densità differenziata.
Differentiated density polyurethane.
Polyurethan differenzierter Dichte.
- 2:** Poliuretano. Polyurethane. Polyurethan.
- 3:** Fibra Poliestere. Polyester Fibre.
Polyesterfaser.
- 4:** Fusto in legno massello e multistrato.
Frame in solid wood and plywood.
Korpus aus Massivholz, und schichtverleimt.
- 5:** Velfodera. Velfodera. Velfodera.

- 6:** Fodera in tela. Fabric lining.
Unterbezug.
- 7:** Inserto in Poliuretano. Polyurethane insert.
Kern aus Polyurethan.
- 8:** Fodera in tessuto antipiuma.
Featherproof fabric cover.
Federundurchlässiger Bezug des Kisseninlets.
- 9:** Piuma. Feathers. Federn.
- 10:** Meccanismo in metallo. Metal mechanism.
Metallmechanismus.

PIEDE FOOT FUSS

- Fusione di alluminio verniciato color bronzo.
Bronzed painted aluminium cast.
Aluminiumguss bronzefarben.

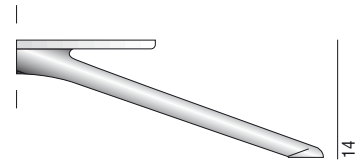

**BASE POLTRONA GIREVOLE E POUF
BASE FOR SWIVEL ARMCHAIR AND POUF
UNTERGESTELL DREHSESSEL UND HOCKER**

- Fusione di alluminio verniciato color bronzo.
Bronzed painted aluminium cast.
Aluminiumguss bronzefarben.

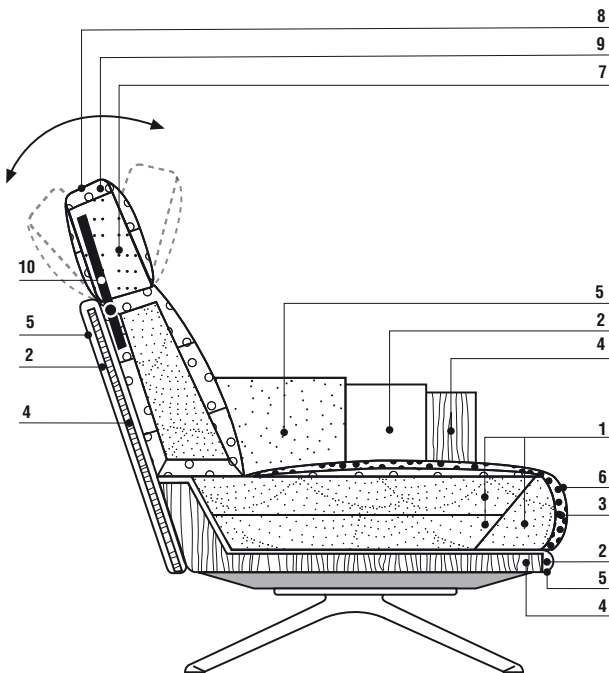
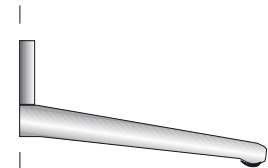

VERSIONE ALTA

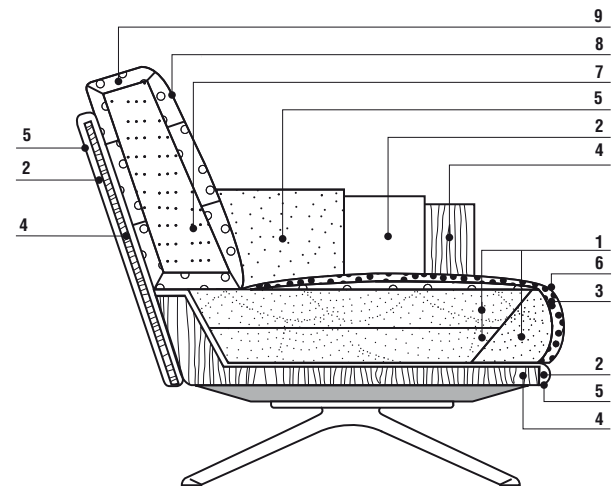

VERSIONE BASSA

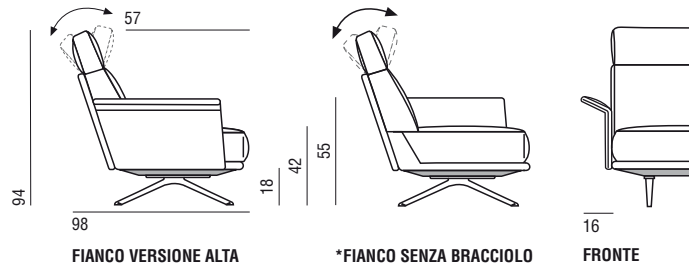

FIANCO VERSIONE ALTA

***FIANCO SENZA BRACCIOLO**

FRONTE

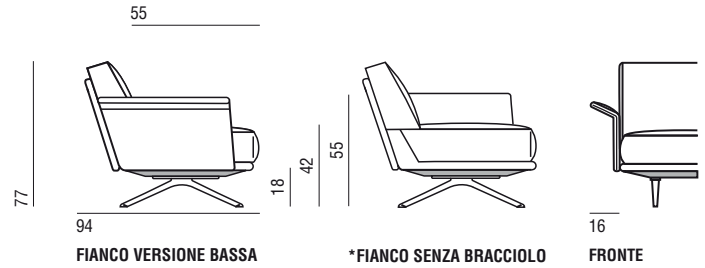

FIANCO VERSIONE BASSA

***FIANCO SENZA BRACCIOLO**

FRONTE

NILSON ALTO

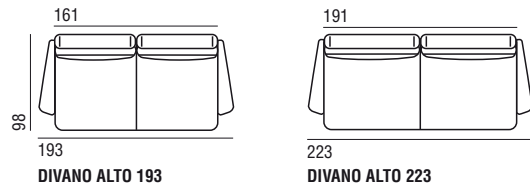

DIVANO ALTO 193

DIVANO ALTO 223

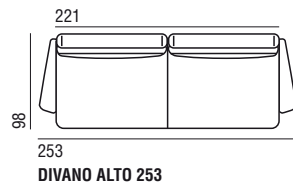

DIVANO ALTO 253

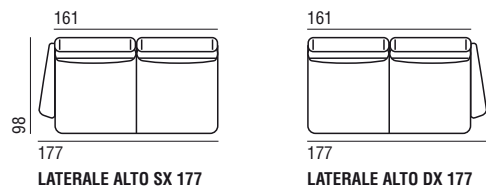

LATERALE ALTO SX 177

LATERALE ALTO DX 177

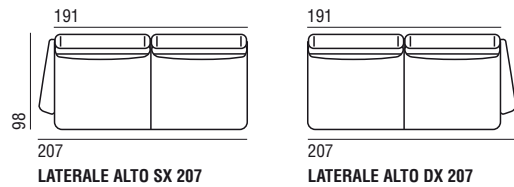

LATERALE ALTO SX 207

LATERALE ALTO DX 207

NILSON BASSO

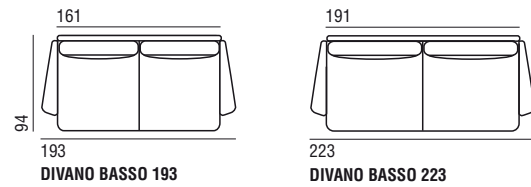

DIVANO BASSO 193

DIVANO BASSO 223

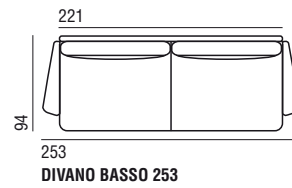

DIVANO BASSO 253

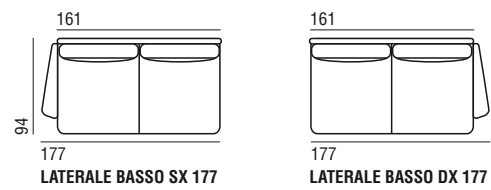

LATERALE BASSO SX 177

LATERALE BASSO DX 177

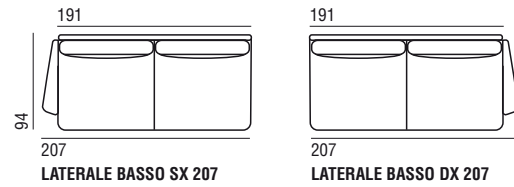

LATERALE BASSO SX 207

LATERALE BASSO DX 207

***FIANCO SENZA BRACCIOLO PROGETTATO SOLO PER ESSERE ACCOSTATO AD ALTRI MODULI.
SIDE WITHOUT ARMREST; DESIGNED TO BE MATCHED WITH OTHER MODULES.
SEITE OHNE ARMLEHNE; NUR ZUM ANBAU AN ANDERE MODULE ENTWORFEN.**

NILSON ALTO

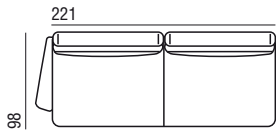

237
LATERALE ALTO SX 237

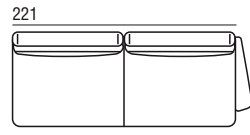

237
LATERALE ALTO DX 237

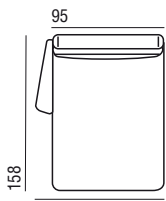

111
CHAISE LONGUE ALTA SX

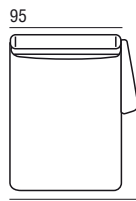

111
CHAISE LONGUE ALTA DX

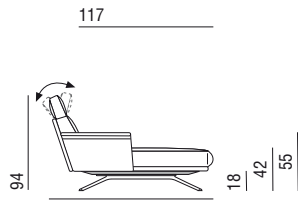

158
FIANCO CHAISE LONGUE ALTA

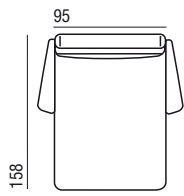

127
POLTRONA LUNGA ALTA

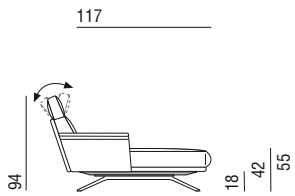

158
FIANCO POLTRONA LUNGA ALTA

NILSON BASSO

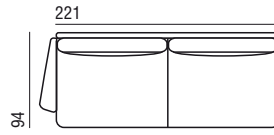

237
LATERALE BASSO SX 237

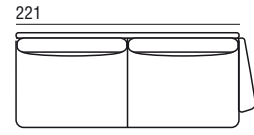

237
LATERALE BASSO DX 237

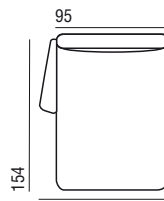

111
CHAISE LONGUE BASSA SX

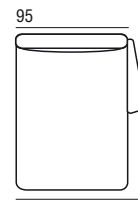

111
CHAISE LONGUE BASSA DX

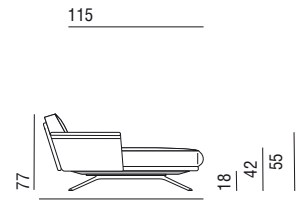

154
FIANCO CHAISE LONGUE BASSA

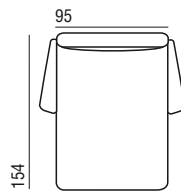

127
POLTRONA LUNGA BASSA

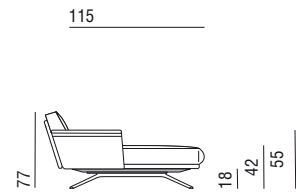

154
FIANCO POLTRONA LUNGA BASSA

NILSON ALTO

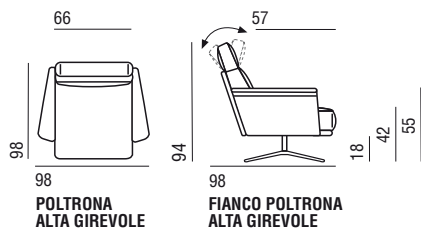

NILSON BASSO

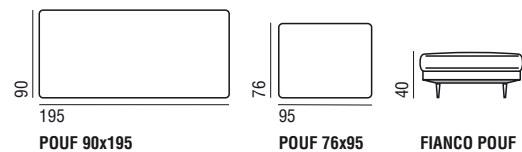
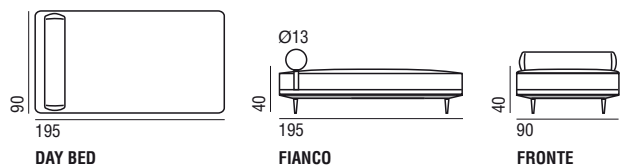
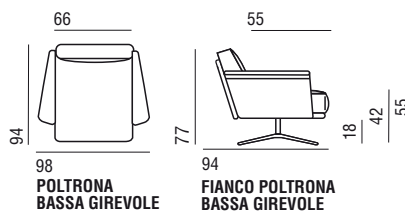

COMPLEMENTI

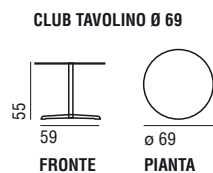
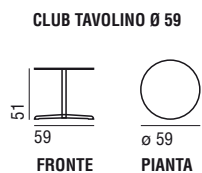

Versione wengé e rigenerato di fibra di cuoio
Version wengé and regenerated leather fibres
Version Wengé und Bonded Leder

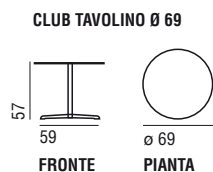
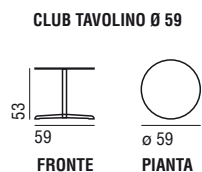

Versione Marmo
Version marble
Version Marmor